

FOCUS+1 ELL



Part number	305095
Lampholder:	LED
Light Source:	LED
Wattage:	18 W
Finish:	AN-96 / Anthracite gray / Textured
Insulation class:	I
Degree of protection:	IP66
IK-J-xxIP:	IK06 1J xx3
CRI:	70
Kelvin:	3000
Power factor:	COSφ ≥ 0,9
EEL:	A2
Optic:	ELLIPTICAL REFLECTOR
Optic Beam:	15°x40°
Lightsource lumen output:	1680 lm
Luminaire lumen output:	1307 lm
L:	L70
B:	B10
Lifetime:	60000 h
Ta MIN luminaire:	-20°
Ta MAX luminaire:	40°



Description

- LED floodlight for indoor and outdoor lighting, comprising:
- Die-cast painted aluminium housing and trim
 - Adjustable mounting bracket made of die-cast aluminium, painted
 - Extra-clear flat tempered glass diffuser with internal screen printing
 - Elliptical lens
 - High power LEDs with next generation high intensity light beam
 - Silicone gasket
 - Stainless steel locking screws
 - Waterproof cable gland M16x1.5 for cables Ø 5- Ø 10 mm
 - Technopolymer peg available for anchoring to the ground
 - Photometric data measure according to UNI EN 13032-4 and IES LM-79-08

Photometric data

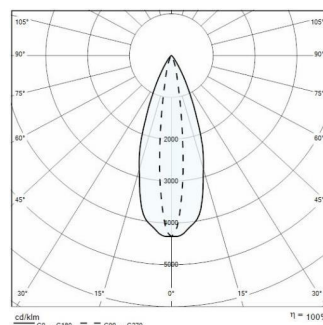

Technical drawings

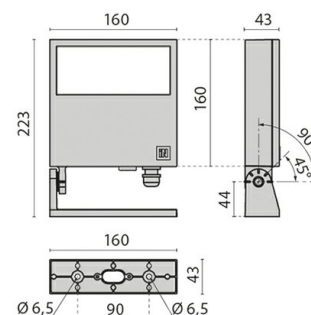

OPTIONAL ACCESSORIES

FOCUS+ 1



700191
Ground spike